

# 15HCX76

**8Ω****Coaxials - 15.0 Inches**

- 99 dB sensitivity
- Single Neodymium magnet assembly
- 800 W continuous program power capacity
- 60°x40° nominal coverage
- 40 - 18000 Hz response
- Modified exponential horn flare for improved acoustic loading and controlled coverage
- 33 mm (1.3") HF unit exit diameter
- Aluminium demodulating ring for very low distortion

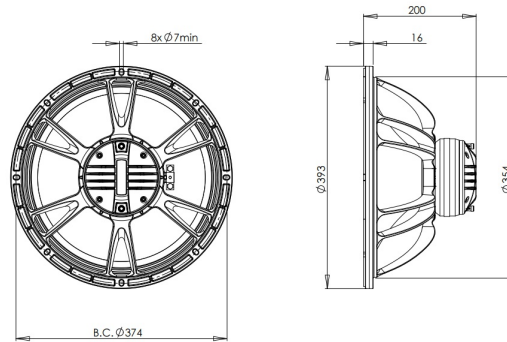

# 15HCX76

Coaxials- 15.0 Inches

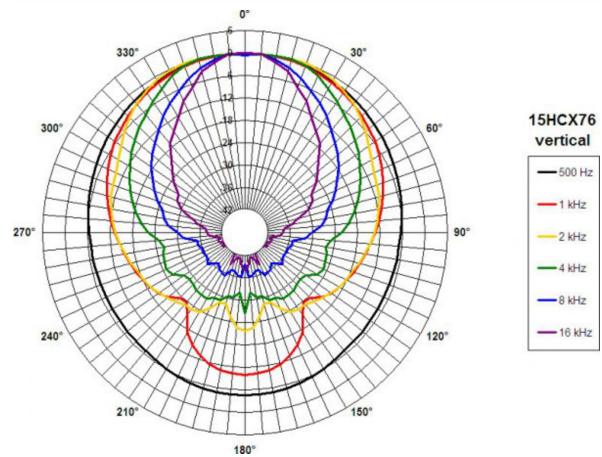
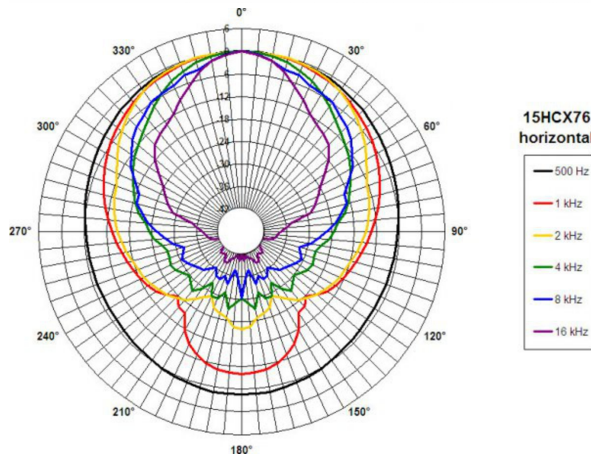
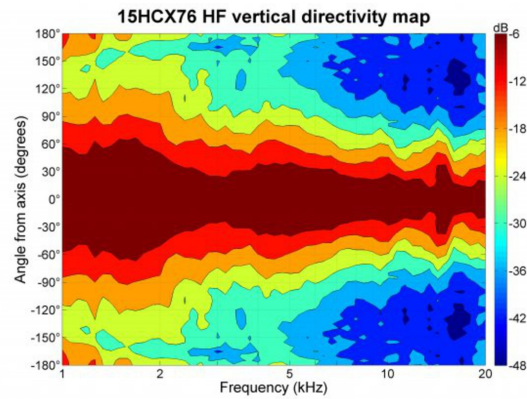
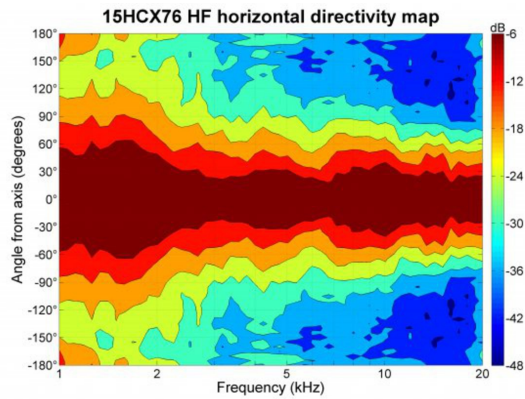
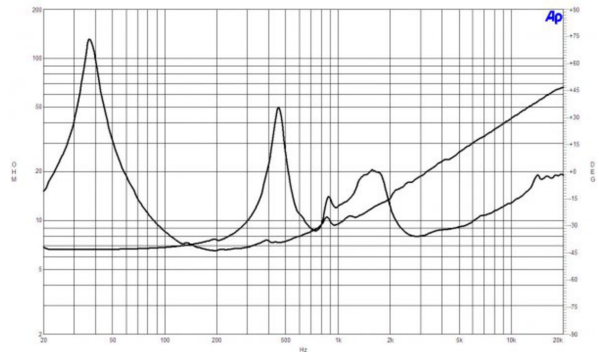
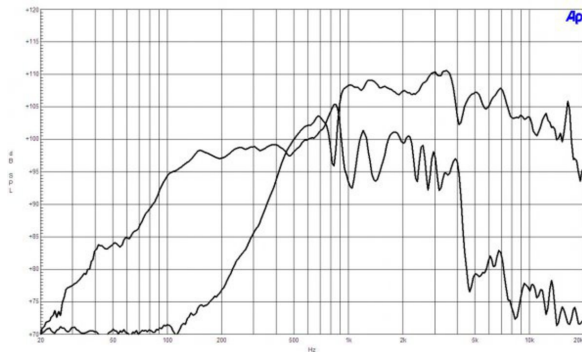

## SPECIFICATIONS

Nominal Diameter	380 mm (15.0 in)
Nominal Impedance	8 Ω
Minimum Impedance LF	6.0 Ω
Minimum Impedance HF	8.0 Ω
Frequency Range	40 - 18000 Hz
Dispersion Angle <sup>1</sup>	60x40 °
Woofer Cone Treatment	WP Waterproof Front Side
Magnet Material	Neodymium Ring

## SPECIFICATIONS LF UNIT

LF Sensitivity <sup>2</sup>	99.0 dB
LF Nominal Power Handling <sup>3</sup>	400 W
LF Continuous Power Handling <sup>4</sup>	800 W
LF Voice Coil Diameter	76 mm (3.0 in)
LF Winding Material	Copper
LF Flux Density	1.15 T
Former Material	Glass Fibre
Winding Depth	16.5 mm (0.65 in)
Magnetic Gap Depth	8.0 mm (0.31 in)

## SPECIFICATIONS HF UNIT

HF Sensitivity <sup>5</sup>	107.0 dB
HF Nominal Power Handling <sup>6</sup>	80 W
HF Continuous Power Handling <sup>7</sup>	160 W
HF Voice Coil Diameter	75 mm (3.0 in)
HF Winding Material	Aluminium
HF Flux Density	1.9 T
Diaphragm Material	Titanium
Recommended Crossover <sup>8</sup>	1.2 kHz
Inductance	0.14 mH

B&C Speakers s.p.a.

Via Poggiomoro, 1 - Loc. Vallina, 50012 Bagno a Ripoli (FI) - ITALY - Tel. +39 055 65721 - Fax +39 055 6572312 - mail@bcspeakers.com

**PARAMETERS**

Resonance Frequency	38 Hz
Re	5.1 $\Omega$
Qes	0.3
Qms	5.8
Qts	0.28
Vas	246.0 dm <sup>3</sup> (8.6 ft <sup>3</sup> )
Sd	855.0 cm <sup>2</sup> (132.5 in <sup>2</sup> )
$\eta_e$	3.7 %
Xmax	± 4.5 mm
Xvar	± 6.0 mm
Mms	82.0 g
Bl	17.8 Txm
Le	0.9 mH
EBP	126 Hz

**MOUNTING AND SHIPPING INFO**

Overall Diameter	393 mm (15.5 in)
Bolt Circle Diameter	374 mm (14.7 in)
Baffle Cutout Diameter	354 mm (13.94 in)
Depth	200 mm (7.87 in)
Flange and Gasket Thickness	16 mm (0.62 in)
Net Weight	6.0 kg (13.23 lb)
Shipping Units	1
Shipping Weight	7.6 kg (16.76 lb)
Shipping Box	500x495x275 mm (19.69x19.49x10.83 in)

**SERVICE KIT**

LF recone kit	RCK15HCX768
MF replacement diaphragm	MMD3BTN8M

1. Included by -6 dB down points.
2. Applied RMS Voltage is set to 2.83V.
3. 2 hours test made with continuous pink noise signal within the range Fs-10Fs. Power calculated on rated minimum impedance. Loudspeaker in free air.
4. Power on Continuous Program is defined as 3 dB greater than the Nominal rating.
5. Applied RMS Voltage is set to 2.83V.
6. 2 hour test made with continuous pink noise signal within the range from the recommended crossover frequency to 20 kHz. Power calculated on rated minimum impedance. Loudspeaker in free air.
7. Power on Continuous Program is defined as 3 dB greater than the Nominal rating.
8. 12 dB/oct. or higher slope high-pass filter.